



Girl's Playhouse

Girls Play House.

A Girls playhouse house is a playhouse with a few feminine touches added. Using a little imagination, a few custom touches can be added to your play house to create a unique and special environment that can provide children with hours of enjoyment! Add flower boxes, shutters and other window types simply go to our website at www.shedwindowsandmore.com for all of your needs.

This house when finished will stand 78" high, is 92" long and 48" wide with an additional 28" wide deck along the front unless you decide to enlarge it some.

The floor base is constructed of 2x6 pressure treated lumber. The floor is 1x4 deck boards. All the framing is 2x3 with the exception of the ridge beam which is 2x4. The posts also are 2x3.

The Elevation Plans (side)

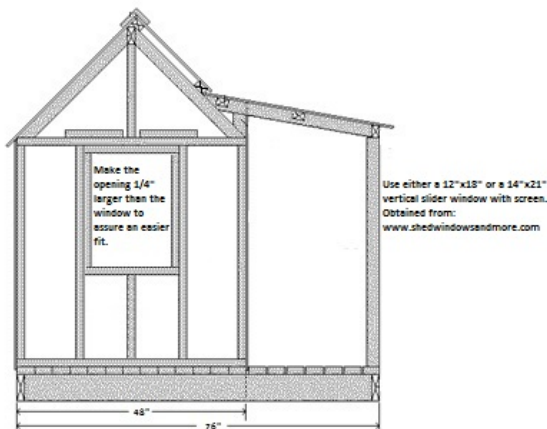

The Elevation Plans (front)

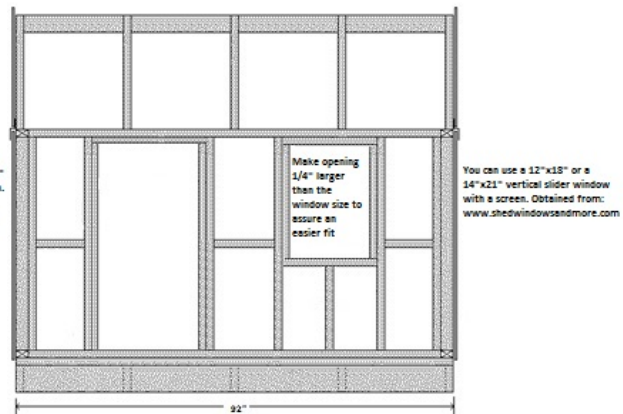

Note: Alternative size framing lumber. All the framing lumber referred to in this project is 2x3. If this stock size is not available in your area, then use 2x4 lumber but make any necessary measurement adjustments.

Let's get started!

Step one: The pieces

The common rafters have a 45° cut at each end.

The lean-to rafters have a 10° cut at one end and a 55° (off square) cut at the other end.

The lean-to rafter supports have a 10° cut at one end and a 45° cut at the other end.

All the other pieces are square cut.

Girls play house roof rafters

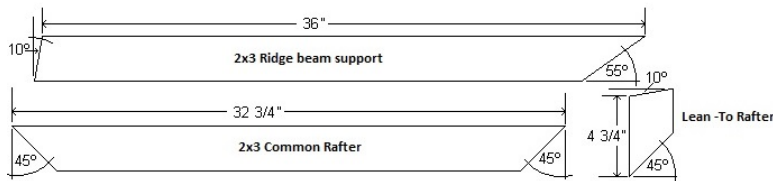

Step two: The base and floor

On a level, flat piece of ground make a rectangle by nailing the two edge (longer) joists to two of the common (shorter) joists.

Nail another three intermediate common joists in place evenly spaced (see floor frame plan below). Use 4" galvanized nails or screws if preferred.

Girls play house floor plan

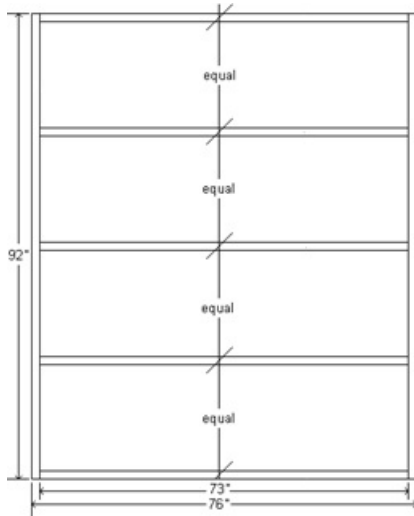

Check that the floor base is square by measuring diagonally from corner to corner. When the diagonals are equal, then the base is square.

Cut as many of the decking boards as possible to the full deck length of 92" and lay and fix them to the floor frame.

Any shorter lengths or off-cuts must join over a joist.

Important! When laying the decking boards, ensure that there will be a 3/8" gap (between the decking boards) along the front of the wall frame to take the bottom of the cladding (siding). See the image below.

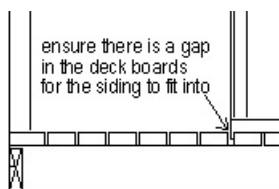

Step three: the wall frames

Lay out the wall frames flat on the Lay the top plates on top of the bottom plates and mark the stud positions on the edge of both plates.

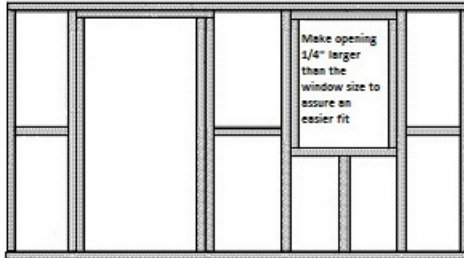

You can use a 12"x18" or a 14"x21" vertical slider window with a screen. Obtained from: www.shedwindowsandmore.com

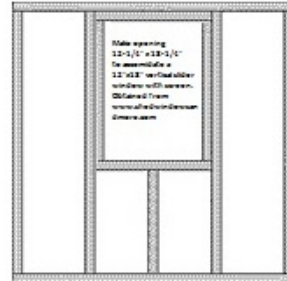

Girls Playhouse Rear Wall Frame

Separate the plates and lay the studs in place. Cut and fix blocking between studs as shown in examples.

Nail or screw the wall frame together.

There will be four wall frames in all, the two end frames and the front and back frame.

Stand the frames up in place and nail or screw together. Ensure the bottom plates are straight and fix to the floor.

Check all corners are vertical (plumb) and fix temporary diagonal braces to the insides of the wall frames if needed.

Step four: the roof frame

Centralize the two ridge supports on top of the two end frames and fix in an upright position.

Balance the ridge beam on top of the ridge supports and fix in place with nails skewed (angled) through the ends of the ridge beam into the supports.

Fix the 10 common rafters in place (5 each side) beginning with the end rafters and then the intermediates.

Fix the lean-to rafter supports in place at the lower end of the top rafters . (See diagram below.)

Fix the lean-to rafters in place on top of the lower rafter supports, and so that the top of the lean-to rafters are at a point $12 \frac{3}{4}$ " up from the bottoms of the top rafters . (See diagram below.)

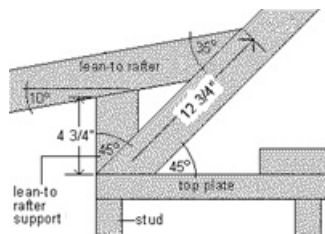

Nail the beam to the end of the lower rafters.

Fix three posts plumb under the beam. One post in the middle and one at each end.

The cladding (siding) and fascia

Step five: Blocking and purlins

From 2x3 lumber, measure, cut and fix two rows of blocking between the lean-to rafters, one row across the top and one row across the middle as shown in diagram below.

Also using 2x3 lumber, fix two rows of purlins on top of the front common rafters. Position as shown in diagram below, with one row at the apex and one row just above the lean-to rafters.

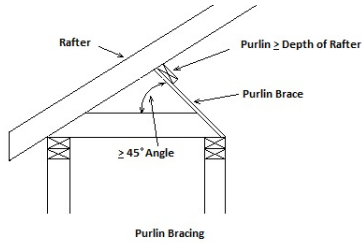

Step six: The wall cladding

From six full 48" x 96" x 9/32" sheets of plywood cut the individual pieces required to cover the walls and roof. You could use other types of siding such as T-111, it's your choice.

Refer to the 'Plywood sheet cutting detail' image for the size of the individual pieces.

Note: You can use 3/8" thick plywood if you want something a bit more substantial.

Plywood sheet cutting detail (6 sheets altogether)

side wall 48" x 48"	back wall 48" x 48"	lean-to roof 40" x 48"
side wall 48" x 48"	back wall 48" x 48"	front wall 56" x 48"
lean-to roof 40" x 48"	back roof 38" x 48"	back roof 38" x 48"
front wall 56" x 48"	front roof 22" x 48"	gable side
	front roof 22" x 48"	gable side
	X	

Fix the wall panels in place so that the bottoms finish 3/8" below the bottom plate. The front panels will need to be checked (marked and cut) around the lower rafters. Mark and cut out any windows (you might want to do a fancy shape here), doors or overhanging edges. Nail with 2" flathead galvanized nails. Keep the door cutout intact, as this will later become the door.

Next hold the gable side panel in place on top of the sidewall panel, mark to the triangular shape of the gable, cut and fix in place. Insert a length of galvanized horizontal weather-strip flashing so it tucks under the bottom of the gable side panel, and over the top of the sidewall panel. See diagram.

Step seven: The roof cladding

The roof plywood panels, and can be fixed in the same way as the wall panels.

The roof panels will overhang the perimeter (front, back and sides) by approximately 2".

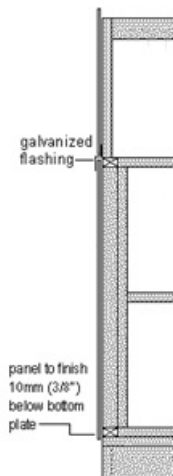

Step eight: The ridge capping, fascia and barge board

The ridge capping, fascia and barge board are (in this case) all the same type of timber, namely 1" x 4" sawn (rough sawn) treated lumber.

The ridge capping is the board on the ridge of the roof and its purpose is for waterproofing. The fascia and barge board are the boards encompassing the house at the top of the walls tucked under the roof cladding overhang.

The board along the front and back of the house is called the fascia board and the board running up the gable on the sides of the house is called the barge board (rake board).

Fix all with 3" galvanized nails.

A pattern can be cut into the fascia and barge board and the shape used is solely a matter of personal preference.

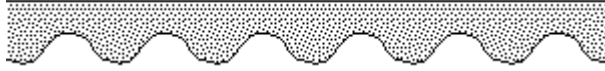

A pattern like this can be made on the fascia and barge boards by using the bottom of a paint tin (or similar) as a template to mark the rounds and then by cutting out with a jigsaw.

Step nine: The door girl's playhouse door

The cut-out piece of plywood saved from the door hole can now be made into the door. Trim the bottom edge (about 3/4") to ensure the door will easily open, and sand the edges. There should be about 1/4" clearance both sides of the door.

Reinforce the door with 1" x 4" wood nailed to the back.

Hold the door in place with packers and wedges and screw on the hinges. See diagram.

Nail a piece of doorstop (1" x 1") down the doorjamb stud, 1 9/32" (the thickness of the door) in from the outside. This acts as both a doorstop and wind and weather seal.

A preferred door handle is a locking T handle with d back obtained from:

www.shedwindowsandmore.com

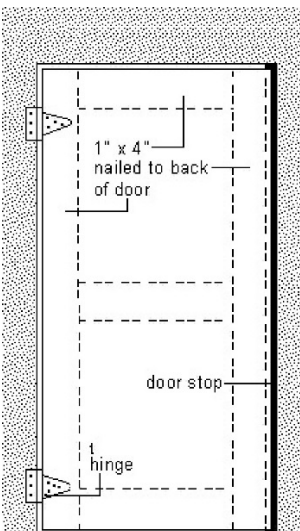

Door Detail

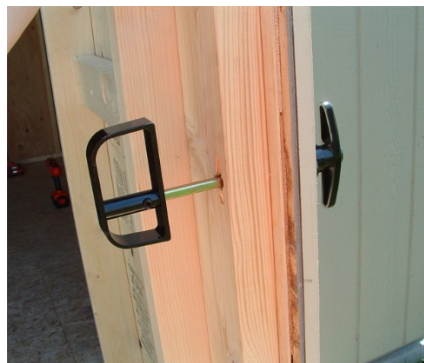

T Handle Detail

Step ten: The windows

Window Framing and Installing

At Shed Windows and More, Inc. we offer a wide range of window sizes and shapes. For our purpose here we will just address the vertical slider (single hung type) windows.

The window frame is important when building a shed since it supports the weight of the wall around the opening using the various studs to transfer the load to the foundation. Starting at the top wall plate the stud called the cripple stud transfers the load from the top plate to the header (two 2x4's or 2x3's nailed together) (for home construction a 2x6 is generally used). At the sides both the jack and king studs support the header and transfers the load to the soleplate or floor. The bottom of the window opening we again use two, 2x4's or 2x3's that are nailed together to form what is called a sill (some call it a rough sill) which while supported by a cripple stud does itself not support any of the wall weight, but merely acts as a place to anchor the base of the window. (see figure 1.)

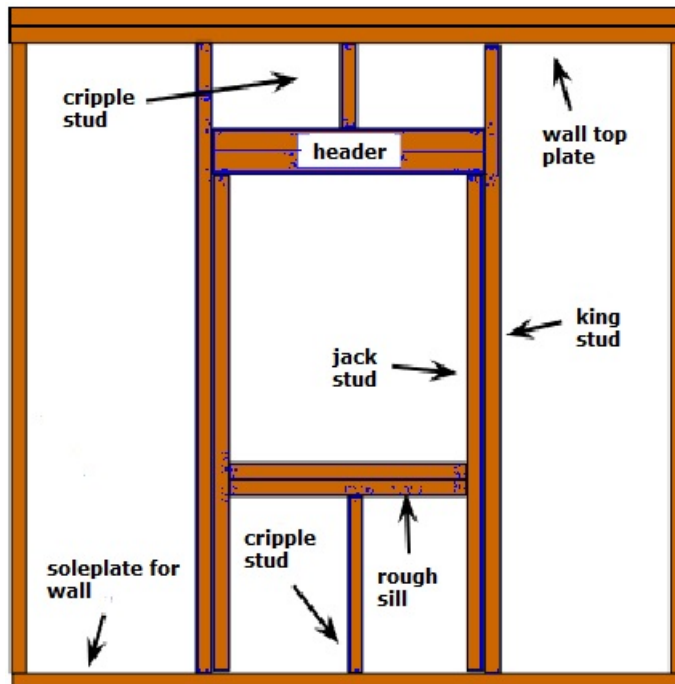

Framing for Window
Figure 1.

The rough opening or buck size can be obtained by going to our catalog page. If you are using an outdoor T-111 type siding on the outside of your shed you can use either the flush mounted window or J channel (sometimes called J lapp) window. After attaching the T-111 to the outside of the framing it is time to cutout the opening for the window. Drill a hole at each corner using a 5/8" drill bit in-order to make the holes large enough to accept a tape measure for marking your cutting lines on the outer siding

and the saw blade of your saber saw to cutout the opening. Before cutting you should fasten a straight, 1x3 board to the siding along the lines to use as a fence to guide the saw blade. Be sure when fastening this guide board that the holes left by these fasteners can be covered by any molding you are going to use. (see Figure 2 & 3) Be sure to take the width of your saws base-plate (including width of the blade) into account when setting the fence board.

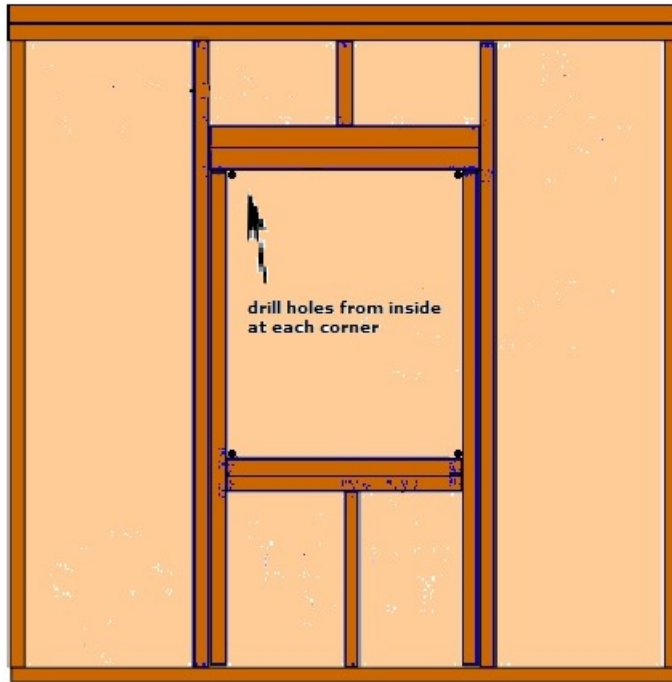

Inside Wall
Figure 2.

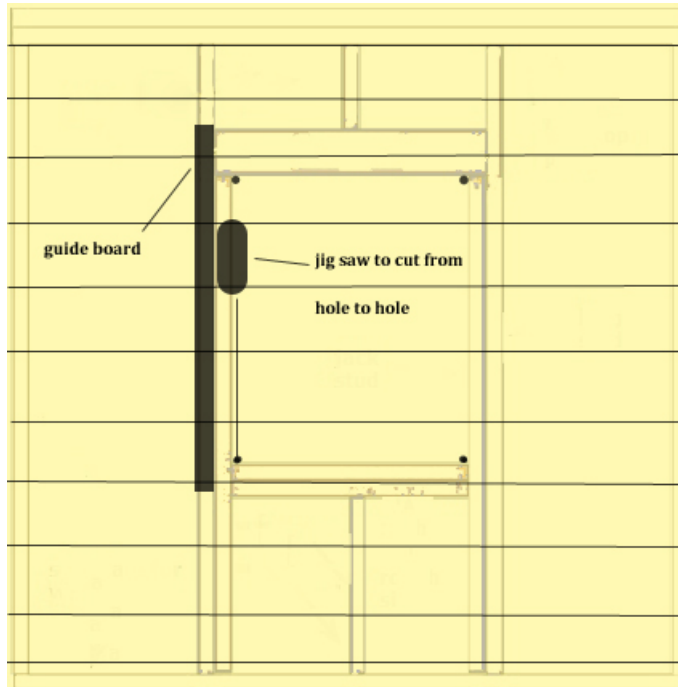

Outside Wall
Figure 3.

If you are using a vinyl siding, the J channel window should be used since it offers a separate channel to accept the vinyl siding. Some people also like to use this channel on the T-111 to use with their trim boards around the windows. (see Figure 4.)



“J” Channel Window
Figure 3.

Remember whenever you are cutting out a hole to add a vent or some other items to always make note where your studs are located and to plan ahead if at all possible.

Step eleven: The handrail handrail for the girls play house

Cut the 2x4 top and bottom rails to length to fit between the posts and cut a channel along the center of each piece.

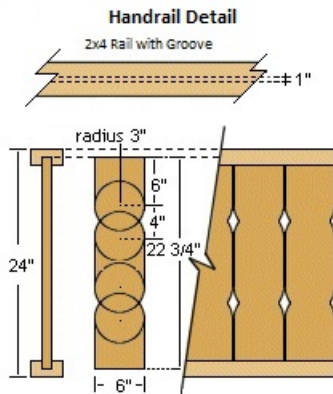

On one side only, pencil two lines 1" apart along the length in the center of the rails. (See handrail detail diagram). Set the blade on your circular saw to a depth of 3/4" and do repeated cuts along and between the two pencil lines.

Clean out with a chisel.

This will give you a groove 1" wide x 3/4" deep along the center of the rails.

Cut 1x6 lumber into 22 1/2" lengths and implement a pattern of your choice.

The pattern shown in the handrail detail diagram is just one idea.

Make the pattern on one piece of board and use that as a template to do the rest.

Fit the boards into the cut grooves in the top and bottom rails.

This is best done by laying the top and bottom rails on the ground and then inserting the boards into the grooves.

If the number of boards does not work out exactly, one of them will need to be marked and ripped (cut) lengthwise.

When one section is finished, tie a rope around each end so the boards will not fall out while that section is being installed.

Nail each section in, and fix the rails to the posts with 4" galvanized nails.

Do this to all 3 sections.

That's it time to have lots of fun!